

## 1941 - 1946 STEPSIDE TAILGATE COVER

### Suggested Installation Instructions:

1. Remove original tailgate.
2. Straighten the tailgate if it is bent or twisted.
3. If installing a louvred tailgate cover, paint the rear face of the tailgate with a flat black paint to prevent the original paint from showing through the louvres.
4. Paint the back side of the cover with rust preventative paint.
5. Place the cover on the tailgate at the top first as shown, then push the bottom over the bottom of the tailgate. It may be necessary to push downward on the cover to permit the bottom of the cover to set properly against the bottom of the tailgate.
6. When properly positioned the cover is seated tightly against the rear face of the tailgate and very little, if any gap will appear at the top between the tailgate and cover.
7. The cover may be either welded or "pop" riveted onto the tailgate. The preferred method is welding at the top and pop rivets or small screws at the bottom.
8. Clamp the bottom and sides of the cover to the tailgate, using care not to damage or dent the tailgate cover. Drill 4 holes for pop rivets through the tailgate cover and into the tailgate. Make sure the cover is fully seated onto the tailgate when drilling the 4 holes. Space them approximately as shown. Install pop rivets to secure the bottom of the tailgate cover.

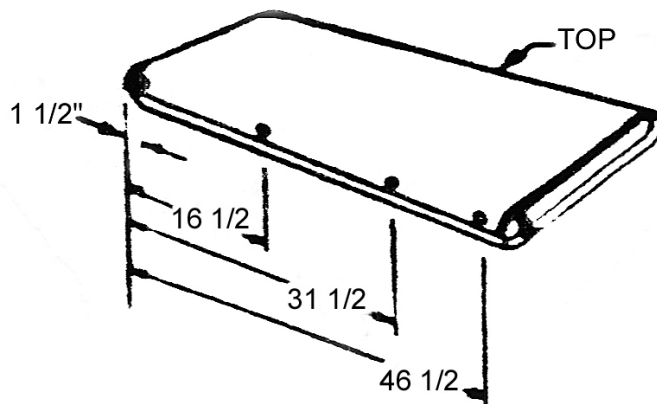
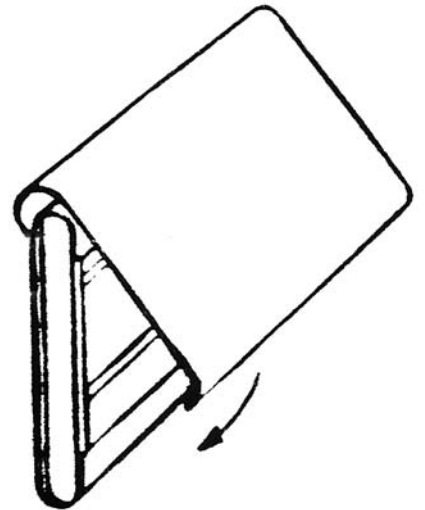

9. When welding the top of the cover to the tailgate use **1/2" maximum** weld beads spaced no more than **3"** apart all along the seam will hold the cover.
10. Grind all welds smooth and fill the top seam with body putty or lead solder to properly finish the seam before painting. Do not fill the bottom seam so that moisture may drain out.
11. Prepare and paint the tailgate as the rest of the box.
12. When installing the tailgate it may be necessary to readjust the trunnions **1/16"** rearward to allow for the extra metal thickness at the bottom of the tailgate.

©Copyright 1997 MAR-K Specialized Mfg. All rights reserved.

Another Outstanding Part Manufactured in Oklahoma City, USA by



---

6625 WEST WILSHIRE BLVD. OKLAHOMA CITY, OK 73132 (405)721-7945 FAX (405) 721-8906  
www.mar-k.com