

# MAR-K

RESTORATION AND CUSTOM PICKUP PARTS

## BED PARTS ASSEMBLY GUIDE 57-59 GM LONG STEPSIDE 97"

If you have not yet disassembled your original bed, make notes or sketches and take pictures of part locations to aid in the assembly procedure. Use the following steps to assemble the entire bed to test fit all parts.

1. Begin with one bed side and the front bed panel. Bolt these together using (5) 5/16"-18 x 3/4" indented hex head screws, (3) lock washers, and (3) nuts. (Two of these bolts thread into a plate welded into the curl area of the front bed panel.) See figure 1.
2. Bolt the front bed panel to the other bed side with (5) 5/16"-18 x 3/4" indented hex head screws, (3) lock washers, and (3) nuts.
3. Fit the rear cross sill inside the lower portion of the bed side rear stake pockets with the open side of the rear cross sill facing downward. The large mounting brackets should be facing toward the front bed panel. See figure 2.
4. Using (10) 5/16"-18 x 3/4" indented hex washer head bolts, nuts, and lock washers, bolt the rear cross sill to the stake pockets. See figure 3.
5. Once these four pieces of the bed are assembled, make sure your bed is square. Measure the bed width at the top and bottom of bed sides to ensure that the bed sides are straight up and down and are **50"** apart. See figure 4. Tighten the rear cross sill bolts.

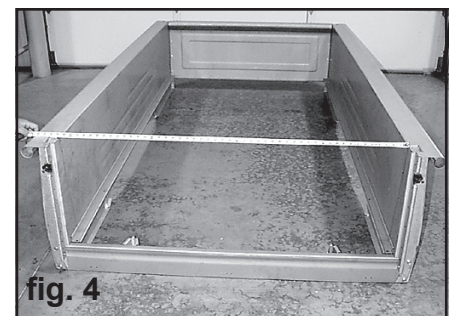
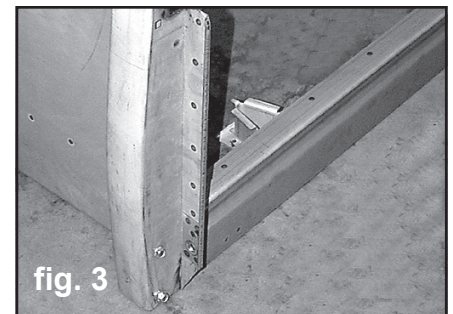
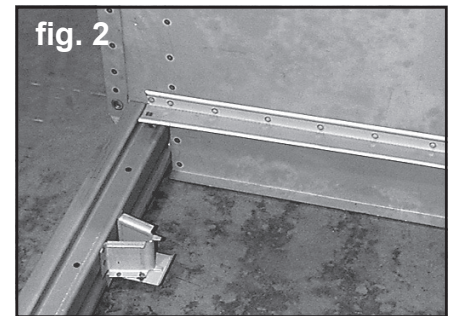
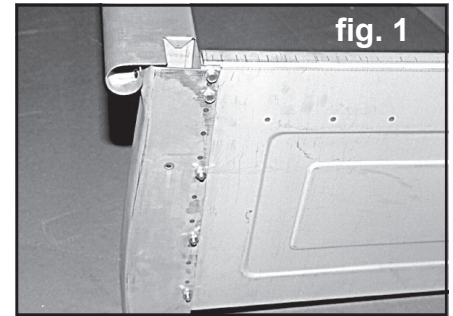

6. Measure crosswise from the front of the bed to opposite rear of the bed on both sides. See figure 5. These measurements should be within 1/16" of each other to ensure bed squareness. Now tighten all bolts.

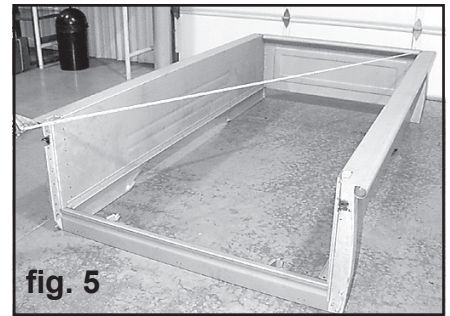

7. Place the assembly on supports horizontally to gain access to both the top and bottom of the bed floor area.

8. Place the wood boards that have only one bed strip groove (referred to as "edge boards") under the angle strips on the bed sides. The non-grooved edge should be toward the bed side. Leave approximately a 1/16" gap between the bed sides and the boards. See figure 6.



9. Mark all holes to be drilled in the wood boards through the angle strip holes. See figure 6.

10. Remove these two boards and drill all marked holes using a 3/8" wood bit. Be careful not to splinter the other side of the board when drilling. Placing a wood block behind the board where drilling will help prevent this. See figure 7.



11. Install the edge boards underneath the angle strips as in step #8. Place 5/16"-18 x 1-1/2" carriage bolts through the angle strips and through the boards. See figure 8. Leave off the lock washers and nuts for now.



12. Attach the cross sills to the angle strip bolts approximately **2-1/2"**, **27-3/8"**, **65-1/2"** and **79-7/8"** from the front bed panel. Install the lock washers and nuts hand tight. The cross sills should be installed so that when the bed is installed on the frame the cross sills should be open toward the ground. The holes in the side of the sill for the step brace should face towards the front. See figure 9.

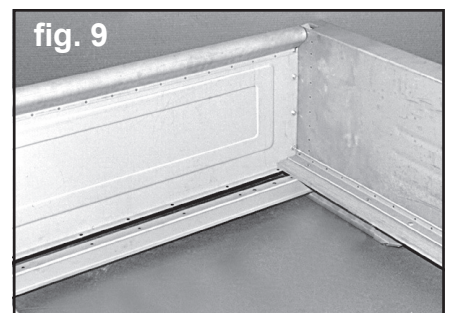

13. Place the next board into position on both left and right hand sides leaving approximately a 1/2" gap between the boards.

14. Install a bed strip between these boards. The front of the bed strip is the end with two holes closest together. The second, fourth, seventh, and eighth bed strip holes should line up with the cross sills. *If using MAR-K's custom bed strips with hidden fasteners, follow the instructions supplied with the bed strips for correct installation.*



15. Loosely install the 1/4"-20 x 1-1/4" carriage bolts, lock washers, and nuts into the strips and the cross sills. See figure 10.

**Note:** The next step is to drill and countersink the locations for the bed-to-frame bolts and offset washers that sit on the top of the wood surface. If wood is purchased with the bed-to-frame holes predrilled, skip to step #24. If wood is purchased without holes, the following steps will direct you through this process.

16. The four cross sills are the locations for the bed-to-frame mounting bolts. Mark the locations on the bottom of the wood boards through the 1/2" diameter holes that are 31-3/4" apart on each cross sill. See figure 11.

17. The fifth bed-to-frame bolt location near the rear of the bed does not pass through a small cross sill. There are two brackets attached to the rear sill. These large brackets should fit against the bottom of the wood boards. See figure 12.

18. Mark the bottom of the wood boards through the big brackets. The spacing of the bracket holes in reference to each other should be 31-3/4" apart from center of the hole to the center of the other hole. The dimension to this rear hole from the front of the wood boards should be 94-1/4" to the center of the bed-to-frame location. See figure 12.

19. Make reference as to which end of each board is at the front of the bed. Remove these two center boards and bed strips. The bottom side of these two boards should now have 1/2" diameter holes marked on them. Drill a 1/8" diameter pilot hole through the center of these marks completely through the boards.

20. On the top surface of the boards, measure toward the front of each board 3/16" from the center of each pilot hole and mark the boards for the countersink. See figure 13.

21. Using a 1-9/16" diameter Forstner bit, a drill press if available, or a hand drill, countersink each location approximately 1/8" to 5/32" deep. See figure 14.

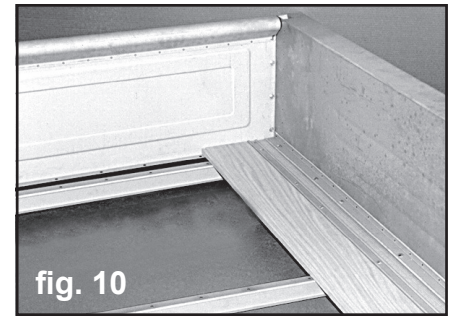

fig. 10



fig. 11

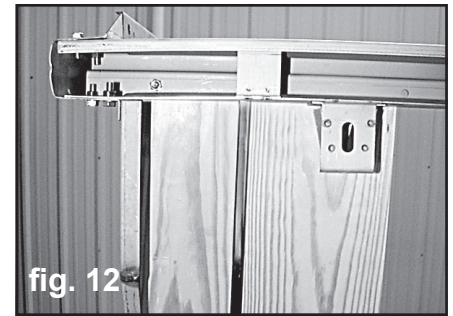

fig. 12

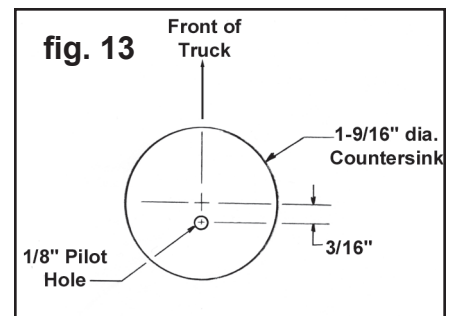
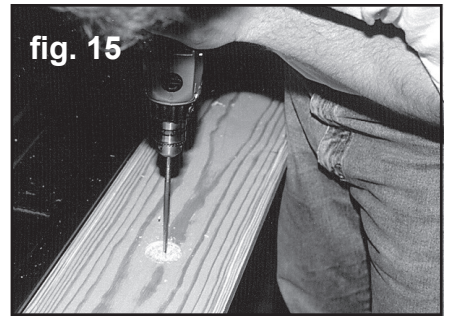

fig. 13



fig. 14

22. From the top surface, drill through the 1/8" pilot holes with a 1/2" wood bit to complete the bed-to-frame holes. See figure 15.



23. Reinstall these boards and strips. Make sure that the bed-to-frame spacing measurements are the same as listed in steps #16 and #18.

24. There are two smaller supporting sills called reinforcement strips that connect to the bed strip bolt approximately **38-3/4"** and **55-1/4"** from the front bed panel.

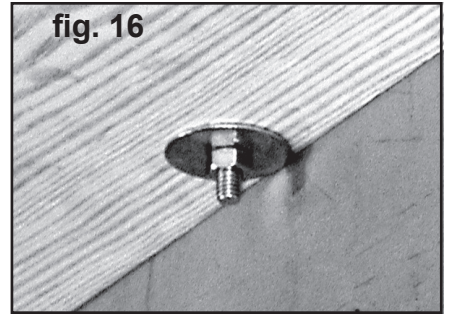

25. Where there is not a cross sill or reinforcement strip attached to the angle strip bolts, install a 1-1/2" outside diameter flat washer with a 5/16" diameter hole on the bottom of the wood surface before installing lock washer and nut hand tight. See figure 16.

26. Where there is not a cross sill or reinforcement strip under the bed strip hole, install a 1-1/2" outside diameter washer with a 1/4" diameter hole before installing lock washer and nut. See figure 17.

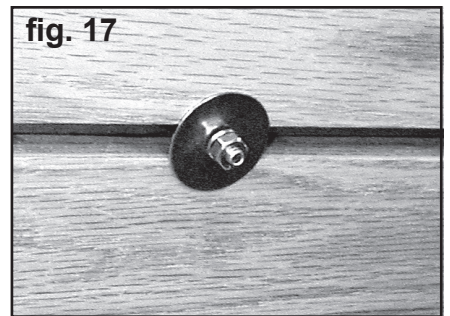

27. Continue installing boards and strips from both sides working towards the center. Remember not to tighten down any bolts completely to leave room for adjustment of boards and or strips from side to side.

28. After the spacing between the bed strips and wood boards has been adjusted, tighten all bed strip and angle strip bolts. Be careful not to tighten bolts too much or broken bolts or damaged bed strips may result.

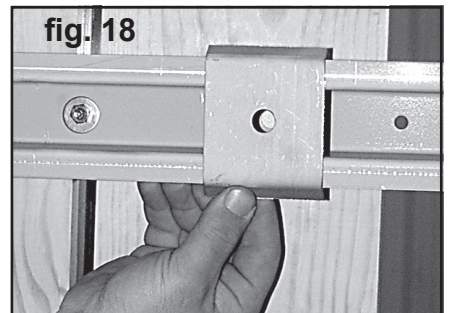

29. Before installing the bed assembly to the truck frame, protect the wood from welding burns and tack weld the cross sill brackets to the cross sills aligning them to the bed-to-frame locations in each cross sill. See figure 18.

30. There should be a rubber bed mounting pad at each mounting location. Install the bed assembly to the frame. Secure the bed to the frame using the 3/8"-16 x 4" carriage bolts and offset washers through the top of the wood. Install the 3/8" flat washers, lock washers, and nuts. See figure 19.

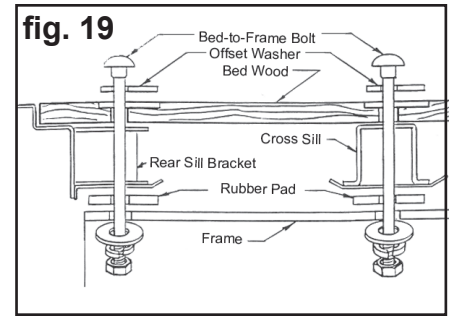

31. Attach one hinge trunnion onto driver bed side rear stake pocket. See figure 20. Install second hinge trunnion into opposite tailgate end pivot area. Mount tailgate on first trunnion and line up second trunnion to bed side hole in right hand stake pocket. See figure 21. Install mounting bolt into right hand trunnion.

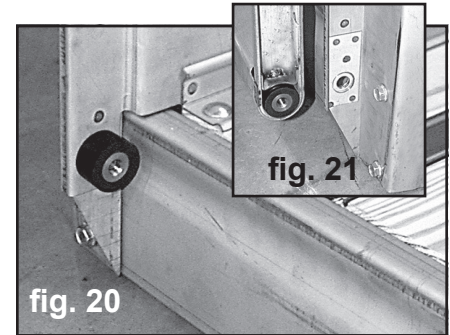

32. Install tailgate chain eye bolts into stake pockets. Secure with the 5/16" lock washers and nuts. This model has a left and right tailgate chain assembly. See figure 22.



33. You have assembled the entire bed. Check all parts for correct fit and alignment. Be sure the bolts are in place and that all dimensions are correct. Now remove the bed from the frame and disassemble the parts to prepare for painting.

### FINAL ASSEMBLY

After the parts are painted, the bed is assembled by the same procedure.

By taking the time to assemble and test fit the bed before painting, you have reduced the chances for errors or problems.



## FACTS ABOUT OUR PARTS

**Stainless Steel:** Bed strips, angle strips, and stainless mouldings are made of type 430 or 434 bright stainless steel, selected because of its color. It is a magnetic grade of stainless formulated for automotive stainless steel trim. When it is polished and buffed, its bright color looks similar to chrome plating. Stainless hardware items such as bolts, nuts, tailgate chain parts, and bed-to-frame washers are made of nonmagnetic stainless selected for superior resistance to rust and corrosion.

**Care of Stainless / Rusting:** With proper care, stainless steel will remain bright and smooth for long periods of time. It may be cleaned with liquid polish intended for stainless or chrome. DO NOT use steel wool, a steel wire brush, or a buffing wheel which has been used on steel or other metals. Bright stainless parts should be coated with a good nonabrasive wax for maximum protection. Stainless steel will rust or corrode under certain conditions, especially when contaminants such as salt water, battery acid, or steel particles and moisture are present. Frequent washing and waxing are a great protection against damage to stainless steel surfaces.

**Electro-galvanized Steel:** Many of the sheet metal parts MAR-K manufactures are made of electro-galvanized steel. This means the metal is electroplated with a thin layer of zinc by the steel manufacturer. There are several reasons for selecting this steel for our product.

1. Electro-galvanized steel is clean and dry.
2. The zinc protects our parts from rusting during our processing and while on the shelf.
3. After the parts are painted, the zinc under the paint helps prevent loss of paint adhesion or rusting if the paint surface is scratched or damaged.

**Preparing Parts for Painting:** The objectives of painting a part are to protect the metal and to provide a beautiful colored surface. No matter how beautiful the paint, if it doesn't stick to the surface, it will not be satisfactory. Excellent paint adhesion to a metal surface depends mainly on two things, the quality and characteristics of the primer used, and how well the surface is cleaned and prepared for painting. Prepare the surface as follows to help the paint have the best adhesion possible.

### **Steps for Excellent Paint Adhesion on MAR-K parts**

The following steps are a general guideline to obtain excellent paint adhesion to your new parts

1. Select the primer product with the best adhesion properties within the paint system you are using. Products such as PPG "DPLF Epoxy Primer", Sherwin Williams G.B.P. Etching Filler or Etching Primer, and DuPont Variprime 615S/625S Self-Etching Primer will provide excellent adhesion to MAR-K metal parts that have been properly prepared for painting.
2. Wipe the part with solvent such as PPG DX330 Wax and Grease Remover, Sherwin Williams R7K156 Solvent Cleaner, or DuPont 3919S Prep-Sol to remove grease and lubricants from the manufacturing process.
3. Scrub all surfaces of the part with mild detergent in hot water. Rinse well and wipe dry with a clean dry cloth.



4. Wipe the part again with solvent as in step 2 above. The surface must be absolutely clean before sanding to prevent the sanding process from spreading the contaminants or imbedding them into the surface.
5. Scuff sand all areas to be painted using progressively finer grit to about 240 grit paper. Do not try to completely remove or sand through the zinc plating, but the complete part must be thoroughly sanded for best paint adhesion. Use a "DA" sander for broad flat areas and hand sanding for areas that can't be reached with the power sander.
6. Wash and rinse away all sanding residue. Use compressed air to blow the rinse water out of all seams and dry the parts with a clean towel. If the rinse water beads up anywhere on the surface, it is not clean and the solvent wipe and water washing steps must be repeated and additional sanding may be required in that area.
7. Wipe with solvent such as PPG DX330, Sherwin Williams R7K158, or DuPont 3901S to remove any traces of contaminants or sanding residue. Wipe the surface dry with a clean cloth. Do not allow the solvent to evaporate dry on the surface. Wet it again if it should evaporate dry.
8. The parts should be ready for prime painting. PPG recommends a final wipe with a clean damp cloth to remove any residue left from evaporation of the solvent. A quick wipe with a tack rag right before priming helps remove any remaining dust.
9. Immediately after cleaning and drying the parts as above, apply the primer according to the manufacturer's instructions for the products you are using. The recommended drying time between coats is especially important.

**Some other helpful hints for a successful paint job.**

1. Be sure to use fresh paint products that are top quality from a reputable manufacturer. Do not try to economize by using inferior or leftover paint materials.
2. Select all the products for a paint job from a single manufacturer and do not mix different systems within a brand of paint. Use only products that are intended to be used together.
3. Do not use the same air hoses on your paint gun that are also used with air tools such as sanders and air wrenches. Oil in the air tools will find its way into the hose and be a source of contamination for the paint. New hoses contain oils and other contaminants and should be cleaned before use on a paint gun.
4. Wear clean latex or nitrile gloves to prevent fingerprint oils from contaminating the surfaces of your cleaned parts.
5. Plan to prime the parts immediately after cleaning and sanding to prevent any bare steel areas from developing surface rust or the parts from becoming contaminated again.
6. Obtain a technical data sheet for each product being used and read and follow the instructions. The manufacturer's data sheet will provide specific instructions that apply to the product being used. These are available on-line or from your paint supplier.

©Copyright 2007 MAR-K Quality Parts L.L.C. All rights reserved.